

功率限制
18W:0K
24W:3.9K
30W:9.1K
45W:16K
60W:24K

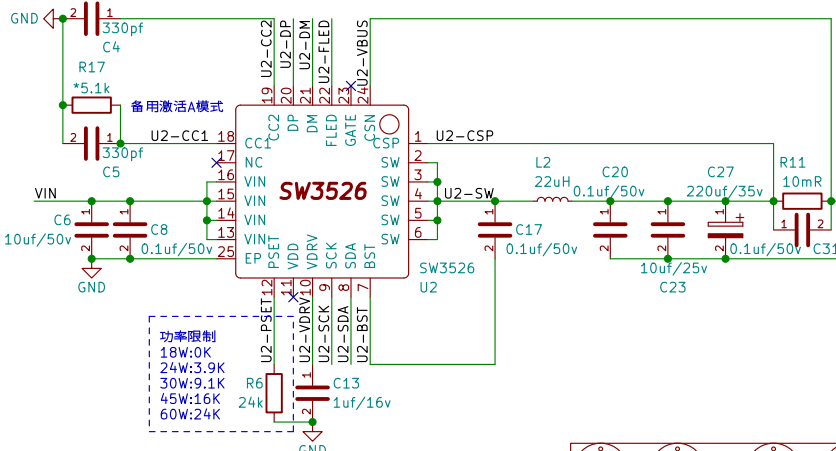

功率限制
18W:0K
24W:3.9K
30W:9.1K
45W:16K
60W:24K

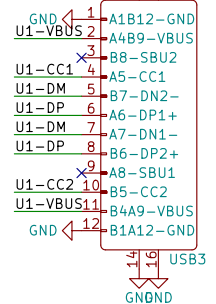
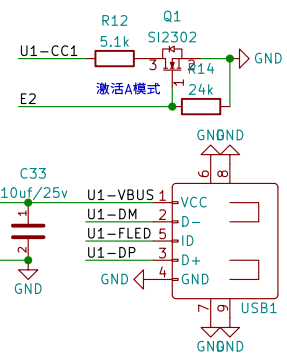
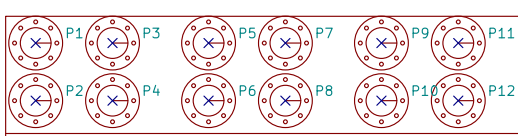
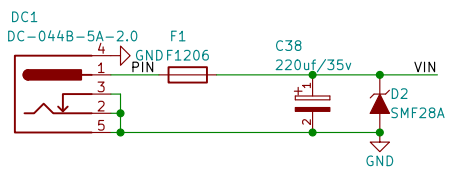
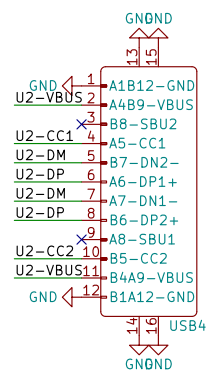
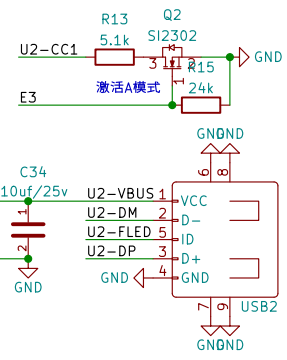

| | | | |
|---|-------|-------|---------|
| Sheet: / | | Date: | |
| File: Power-SW3526.kicad_sch | | | |
| Title: | | | |
| Size: A4 | Date: | | Rev: |
| KiCad E.D.A. kicad (6.0.0-rc1-94-gbbafce6ab3) | | | Id: 1/1 |